

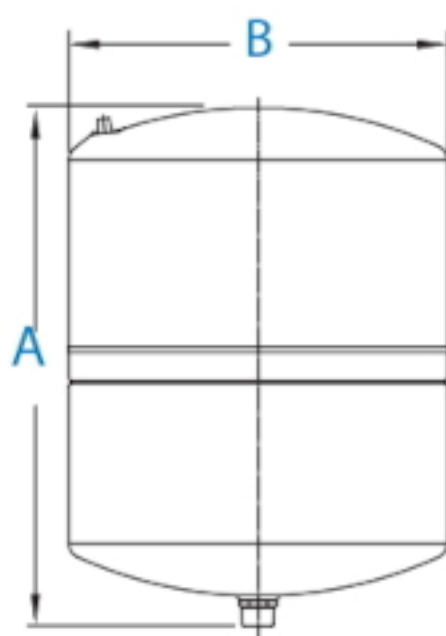

Codice	Capacità (L)	Raccordo	Dimensioni mm		
			A	B	C
PWB-12LX	12	1" GAS M	367	230	

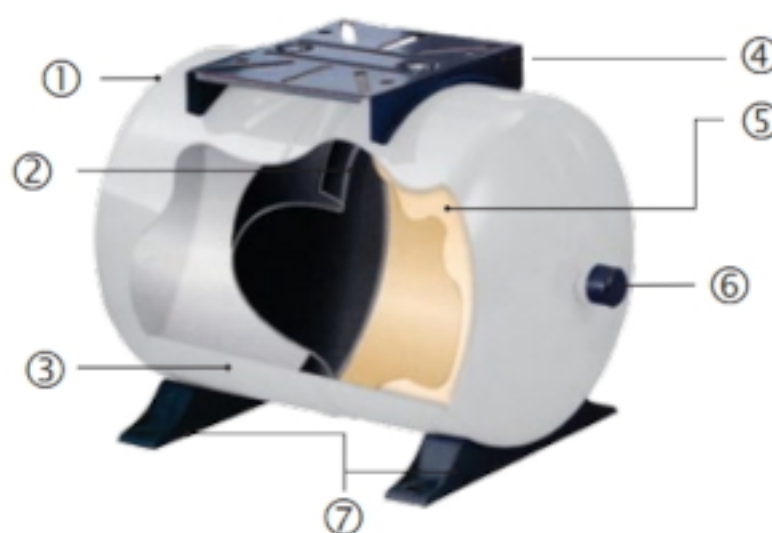

12LX, 18LX, 24LX



- ① Valvola ermetica filettata
- ② Design a diaframma singolo
- ③ Vernice poliuretana bicomponente applicata ad un fondo epossidico
- ④ Supporto per pompa
- ⑤ Rivestimento in polipropilene originale
- ⑥ Raccordo idraulico brevettato e realizzato in acciaio INOX
- ⑦ Supporti in plastica